

## Intelligent Tunable White LED Driver (Constant Voltage)

- The housing is made of V0 flame-retardant PC material, sourced from SAMSUNG/COVESTRO.
- Features a tool-free clamshell design with detachable end caps, allowing length adjustment as needed.
- Via NFC-enabled mobile app, users can adjust dimming mode, PWM frequency, brightness range, and interact with driver data.
- Supports 0-10V, PUSH DIM/CCT and corridor light DIM/CCT.
- Provides two-channel independent SELV outputs.
- Constant power design ensures consistent brightness across color temperature adjustments.
- Supports deep dimming from 0-100%, with a minimum dimming level of 0.01%.
- It is equipped with a soft-start gradually brightening function, making the visual experience more comfortable for the human eye.
- The dimming interface is equipped with photoelectric isolation and complies with the latest safety regulations and standards, making it safer and more reliable.
- Complies with the EU ERP Directive on energy efficiency, with no-load power consumption < 0.5W and network standby power consumption < 0.5W.
- Equipped with an advanced thermal management system to protect internal components.
- Over-temperature, over-voltage, overload, and short-circuit protection, with automatic recovery.
- Suitable for Class I / II / III indoor luminaires.
- The service life can reach 100,000 hours under normal use.
- 5-year warranty (Rubycon capacitor).

### Flicker-Free

IEEE 1789  
Achieve the exemption level.  
5 in 1 dimming

0-10V  
1-10V  
10V PWM  
RX  
PUSH DIM/CCT

Current consumption of the 0-10V interface < 0.05mA

Dimmable:  
1 : 10000



The certification icon represents undergoing certification applications only, and final certification qualification subject to actual product.

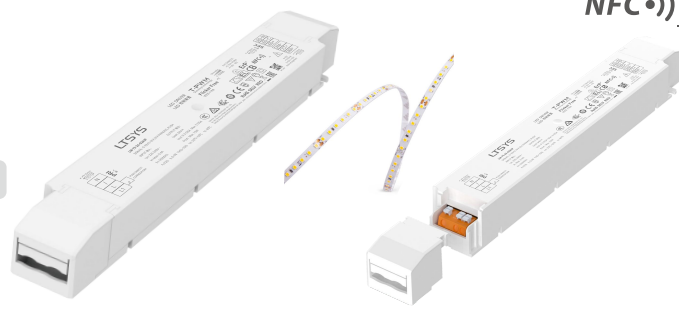

## Technical Specs

Model	LM-75-24-G2A2F			
Features	Output Type	Constant voltage		
	Dimming Interface	0/1-10V, Push DIM/CCT		
	Output Feature	Isolation		
	Protection Grade	IP20		
	Insulation Grade	Class II (Suitable for class I / II / III light fixtures)		
OUTPUT	Output Voltage	24V $\overline{=}$		
	Output Voltage Range	24V $\pm$ 0.5V $\overline{=}$		
	Output Current	Max. 3.125A		
	Output Power	Max. 75W		
	Output Power Range	0~75W		
	Strobe Level	High frequency exemption level		
	Dimming Range	0-100%, down to 0.01%		
	Overload Power Limitation	$\geq$ 102%		
	Ripple	$\leq$ 300mV		
PWM Frequency	300-22000Hz			
INPUT	Input AC Voltage	220-240V~		
	Input DC Voltage	220-240V $\overline{=}$ (EMI needs to be evaluated after the lamp is equipped.)		
	Frequency	50/60Hz		
	Input Current	Max. 0.4A/230V~		
	Power Factor	PF>0.98/230V~ (at full load)		
	THD	THD<10%@ 230V~(at full load)		
	Efficiency (Typ.)	92%		
	Inrush Current	Cold start 45A(Test twidth=300us tested under 50% Ipeak)/230Vac		
	Anti Surge	L-N: 2KV		
	Leakage Current	Max. 0.5mA		
ENVIRONMENT	Working Temperature	ta: -20 ~ 50°C tc: 80°C		
	Working Humidity	20 ~ 95%RH, non-condensing		
	Storage Temperature/Humidity	-40 ~ 80°C, 10~95%RH		
	Temperature Coefficient	$\pm$ 0.03%/°C(-20°C-50°C)		
	Vibration	10~500Hz, 2G 12min/1cycle, 72 min for X, Y and Z axes respectively		
PROTECTION	Overheat Protection	Intelligently adjust or turn off the output current if the PCB temperature $\geq$ 110°C, and recover automatically		
	Overload Protection	Automatically protect the device when the load exceeds 102% of the rated power. Automatically recover once load is reduced		
	Short Circuit Protection	Enter hiccup mode if short circuit occurs, and recover automatically		
	Overvoltage Protection	Shut down the output when no-load voltage $\geq$ 28V, and recover automatically		
SAFETY & EMC	Withstand Voltage	I/P-O/P:3750V~		
	Insulation Resistance	I/P-O/P: 100M $\Omega$ /500VDC/25°C/70%RH		
	Safety Standards	CCC	China	GB19510.1, GB19510.14, GB19510.213
		TUV	Germany	EN61347-1, EN61347-2-13, EN62493
		CB	CB Member States	IEC61347-1, IEC61347-2-13
		CE	European Union	EN61347-1, EN61347-2-13, EN62384
		EAC	Russia	IEC61347-1, IEC61347-2-13
		RCM	Australia	AS 61347-1, AS 61347-2-13
	EMC Emission	ENEC	Europe	EN61347-1, EN61347-2-13, EN62384
		CCC	China	GB/T17743, GB17625.1
		CE	European Union	EN55015, EN61000-3-2, EN61000-3-3, EN61547
		EAC	Russia	IEC62493, IEC61547, EH55015
	RCM	Australia	EN55015, EN61000-3-2, EN61000-3-3, EN61547	
EMC Immunity	EN61000-4-2,3,4,5,6,8,11,EN61547			
ErP	Power Consumption	Networked standby	< 0.5W (After shutdown by command)	
		No-load power consumption	< 0.5W(When the lamp is not connected)	
	Flicker/Stroboscopic Effect	IEEE1789	Meet IEEE 1789 standard/High frequency exemption level	
		CIE SVM	PstLM $\leq$ 1.0, SVM $\leq$ 0.4	
	DF	Phase factor	DF $\geq$ 0.9	
OTHERS	Weight(N.W.)	290g $\pm$ 10g		
	Dimensions	293 $\times$ 42.5 $\times$ 30mm(L $\times$ W $\times$ H)		

This driver is suitable for connecting LED lighting fixtures with resistor current limiting (such as LED light strips). If it is connected to a fixture with built-in constant current IC for current limiting, an instantaneous inrush current dozens of times higher will be generated, causing the driver to activate overload protection (hiccup and strobing). When placing an order, such fixtures with built-in constant current IC for current limiting (e.g., MR16 bulbs, underground lights, wall washers, constant current hard light strips, etc.) need to be specified to facilitate the burning of a special program.

## Product Size

Unit: mm

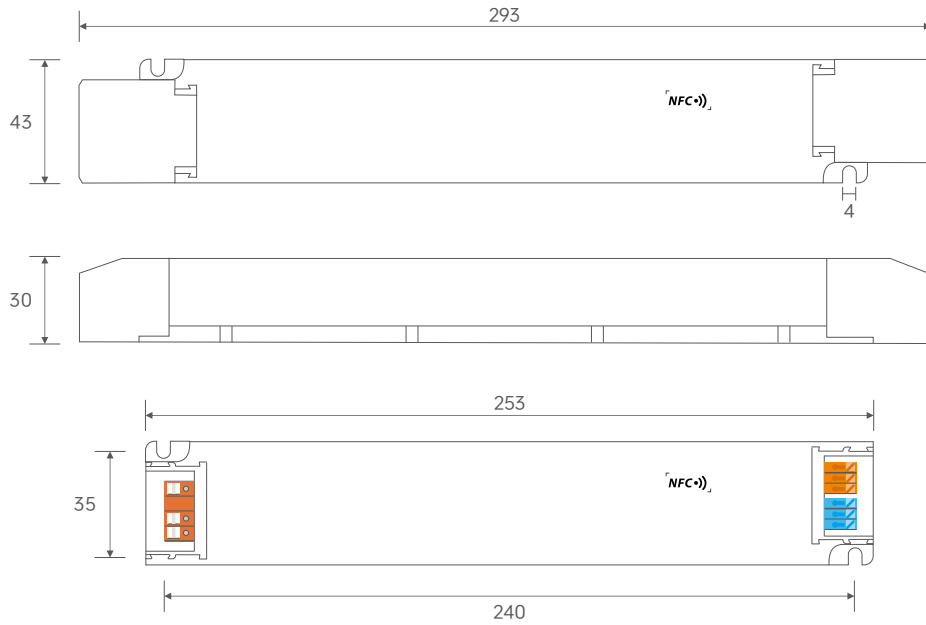

## Wiring Diagram

### 0-10V Connection

#### 1. Dimming: Single Circuit & Single Channel

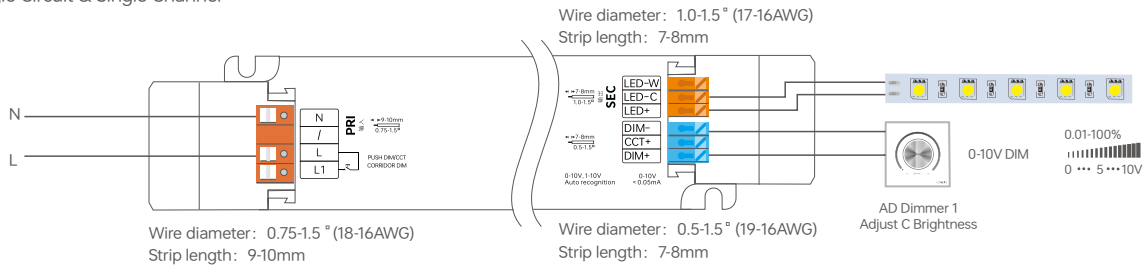

\*Power supplies of different models/wattages vary in hardware. Do not use them for dimming the same light film/light box to avoid inconsistent light activation and dimming. Recommend matching the same light film/light box with a power supply of the same model for consistent dimming.

#### 2. Dimming: Single Circuit & Dual Channels (Maximum power per channel: 37.5W)

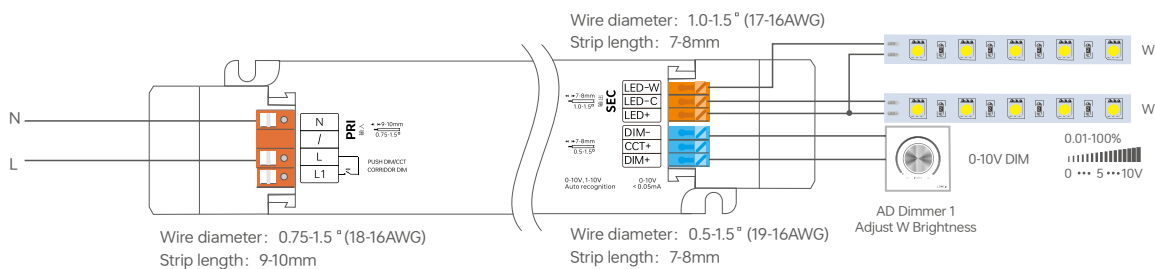

\*Power supplies of different models/wattages vary in hardware. Do not use them for dimming the same light film/light box to avoid inconsistent light activation and dimming. Recommend matching the same light film/light box with a power supply of the same model for consistent dimming.

#### 3. Dimming: Two Circuits & Dual Channels (Maximum power per channel: 37.5W)

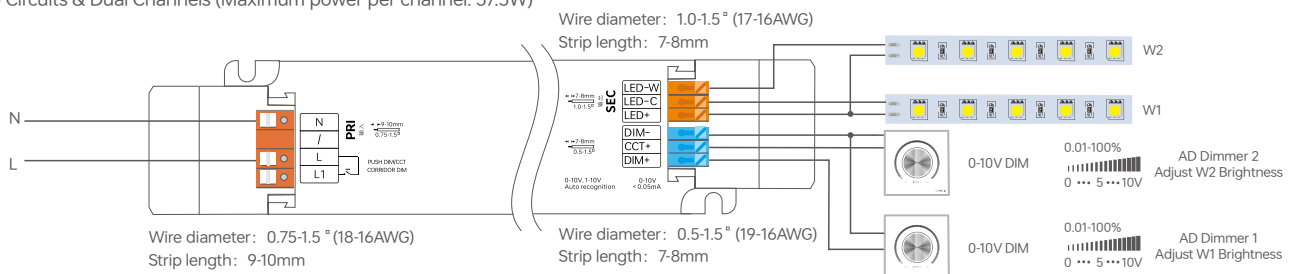

\*Power supplies of different models/wattages vary in hardware. Do not use them for dimming the same light film/light box to avoid inconsistent light activation and dimming. Recommend matching the same light film/light box with a power supply of the same model for consistent dimming.

### 4.CT Mode: 2CH (Two dimming wiring methods)

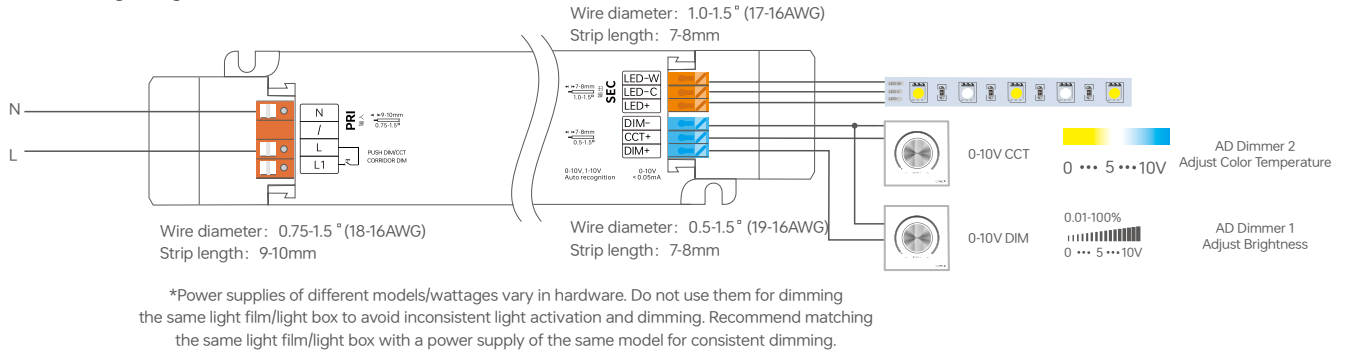

### 5.CT Mode: 2CH (Using a dimming wiring method)

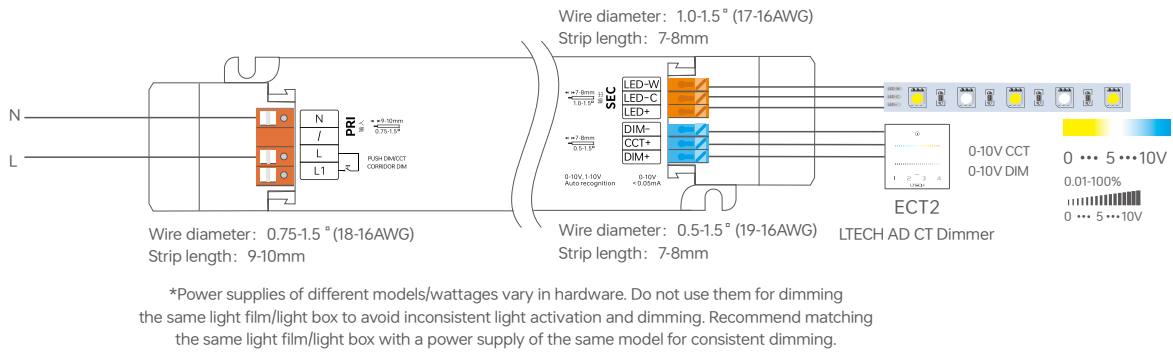

## PUSH DIM/CCT Connection

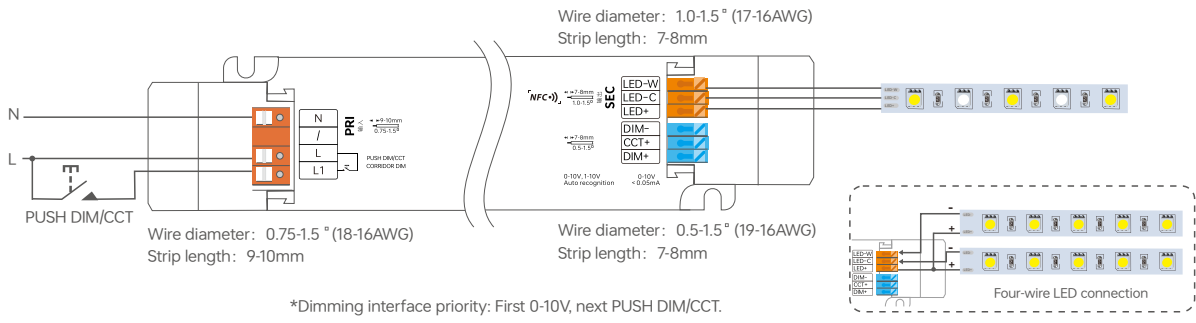

\* Adopting constant power program design, it keeps the same brightness in color temperature dimming, twice the rated power load can be connected.  
75W driver, 75W X 2CH load can be connected, the total power of the 2 channels will be kept in 75W

\*Power supplies of different models/wattages vary in hardware. Do not use them for dimming the same light film/light box to avoid inconsistent light activation and dimming. Recommend matching the same light film/light box with a power supply of the same model for consistent dimming.

### Switch to PUSH Mode:

- Method 1:** If the corridor light has been switched to the PUSH mode, you can connect the circuit according to the Push DIM wiring diagram. Press the reset switch briefly 5 times within 3 seconds, then hold it down for 6 seconds, and then press it briefly 5 times within 3 seconds. The driver will automatically switch to the PUSH mode.
- Method 2:** If the corridor light has been switched to the PUSH mode, it can be switched to the PUSH mode through the NFC Lighting app.

## PUSH DIM/CCT



Reset Switch

- Short press : on/off control.
- Double-click: Double press: Switch brightness/color temperature mode.
- Long press : Adjust the current mode.
- Dimming memory : Upon being switched on again, the light resumes the previously set brightness level.

## Corridor Dimming Application

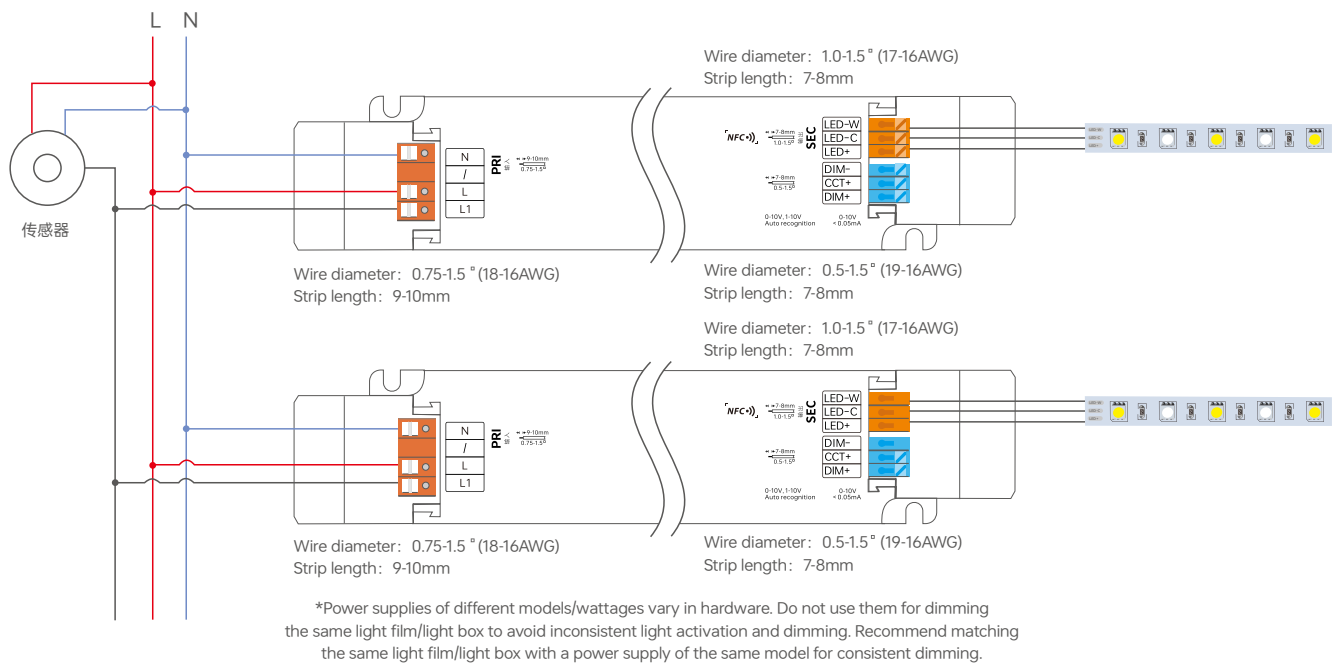

### Switch to the corridor light mode

**Method 1:** Configure and switch the corridor light function via NFC, and the Push function will be turned off.

**Method 2:** After connecting the wires according to the corridor dimming wiring diagram, keep moving within the effective sensing area for more than 2 minutes, and it will automatically switch to the corridor dimming mode with all lights on at full brightness.

**Method 3:** After connecting the wires according to the corridor dimming wiring diagram, first replace the sensor with a common switch, then turn on the common switch and keep it conducting for 2 minutes. The driver will automatically switch to the corridor dimming mode. After that, remove the common switch and replace it with the sensor again.

**Note:** During normal operation, it is recommended to set the hold-time of the motion sensor to the minimum. It is necessary to select a motion sensor with an AC switch.

### Corridor Dimming Working Process

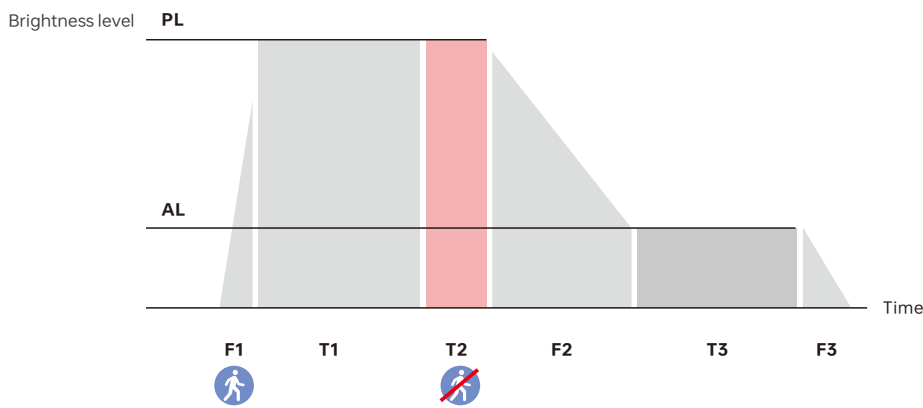

Name	Default	Setting Range
(F1) Fade-in Detection Time	1 s	0-100 s
(PL) Detection Brightness	255	0-255
(PC) Detection Color Temperature	0	0-255
(T1) Induction Hold Time	Set via the sensor	
(T2) Delay Time	30 s	0 s,5 s,10 s,20 s,30 s,45 s,1 min, 2 min, 3 min,5 min,10 min,20 min,30 min
(F2) Gradual Exit Sensing Time	1 s	0-100 s
(AL) Hold Brightness Level	100	0-255
(AL) Hold Color Temperature	0	0-255
(T3) Detection Hold Time	30 s	0 s,5 s,10 s,20 s,30 s,45 s,1 min,2 mins,3 mins,5 mins, 10 mins,20 mins,30 mins,Permanent
(F3) Fade-out Time to Off	1 s	0-100 s

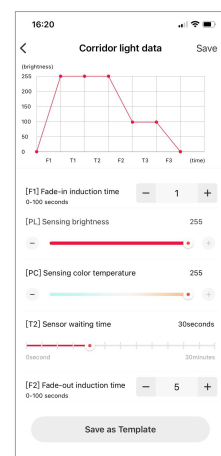

**Note:** \*If the light needs to maintain a low brightness hold, please set the [T3] Detection Hold Time to Permanent.

\*The above parameters are set through the NFC lighting APP.

## Use the NFC Lighting APP

Scan the QR code below with your mobile phone and follow the prompts to complete the APP installation (According to performance requirements, you need to use a NFC-capable Android phone, or an iPhone 8 and later that are compatible with iOS 13 or higher).



\* Before you begin setting the parameters of the driver, please make sure the driver is powered off.

### Read/Write the LED driver

Use your NFC-capable phone to read LED driver data, then edit the parameters and they can be directly written to the driver.

#### 1. Read the LED driver

On the APP home page, click **[Read/Write LED driver]**, then keep the programmer's sensing area close to the NFC sensing area of the driver to read the driver parameters.

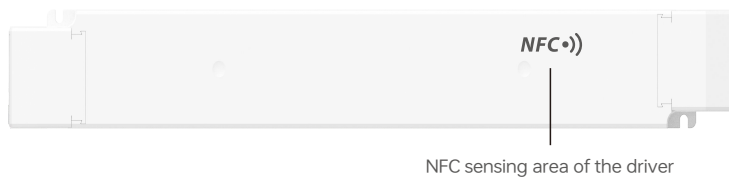

#### 2. Edit parameters

Click on **[Parameter Management]** to edit more advanced parameters such as Select Brand, Dimming Type, Power-on Fading Time, Dimming Curve, PWM Frequency, and Brightness Range.

#### 3. Write to the drive

After completing the parameter settings, click **[Write]** in the upper right corner, and keep the programmer's sensing area close to the NFC sensing area of the driver, so the parameters can be written to the driver.

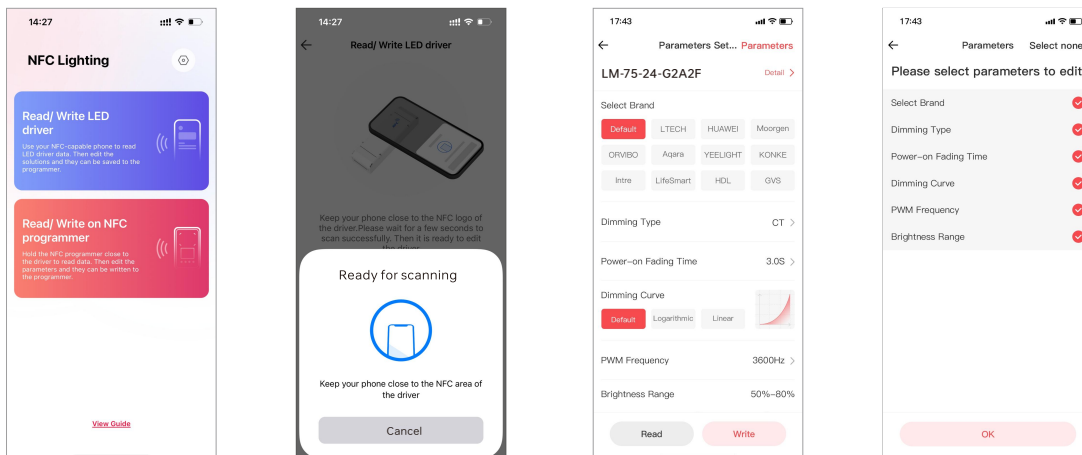

## Protective Housing Application Diagram

### Tension plate

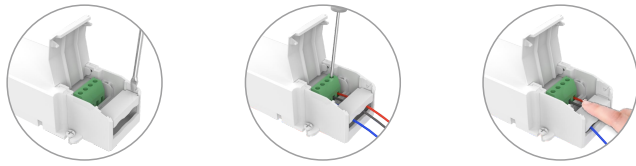

1. Pry up the protecting housing in the side plate position with a tool.
2. Connect to electrical wires with a screwdriver as wiring diagram shows.
3. Press down the tension plate to fix the the electrical wires, then close the protective housing.

### Remove the protective housing

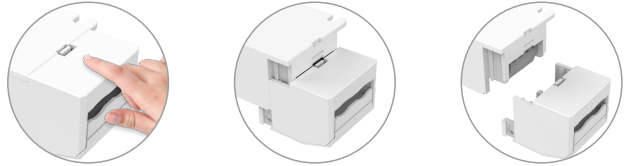

Pull the housing left and right from the bottom to remove it.

## Installation Precautions

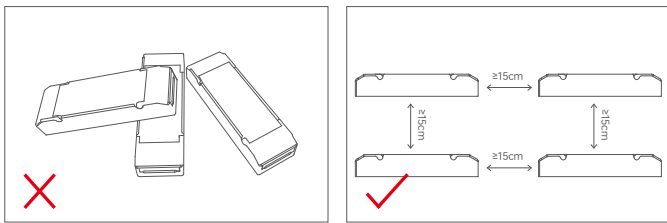

Please do not stack the products. The distance between two products should be  $\geq 15\text{cm}$  so as not to affect heat dissipation or the lifetime of the products.

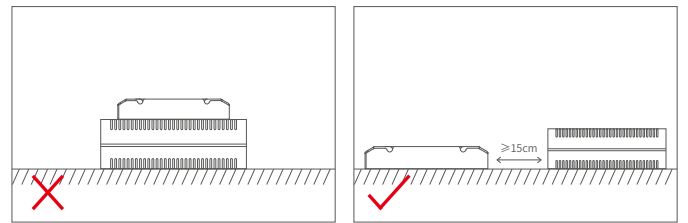

Please not place the products on power supplies. The distance between the product and the power supplies should be  $\geq 15\text{cm}$  so as not to affect heat dissipation or shorten the lifetime of the products.

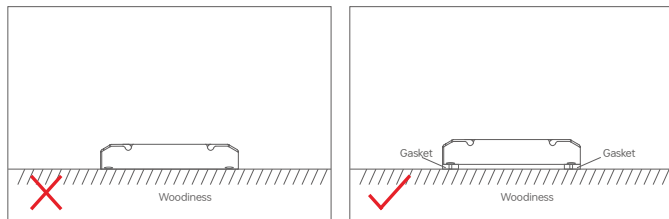

Do not fix the product screws tightly against the wooden board. Instead, add a washer with a thickness of  $\geq 7\text{mm}$  under the fixing screws. Leaving some gaps can effectively dissipate heat, preventing any impact on the product's heat dissipation performance and service life.

## Relationship Diagrams

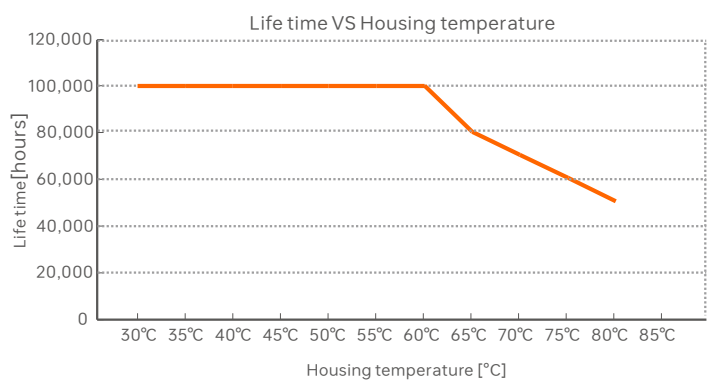
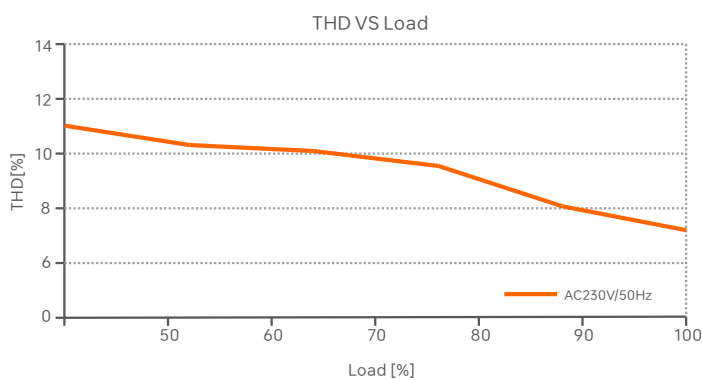
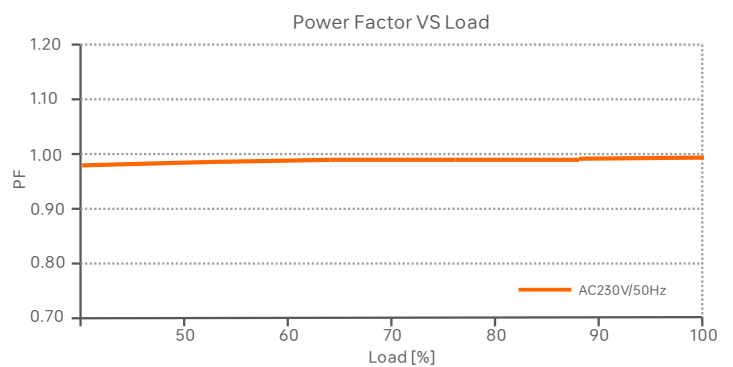
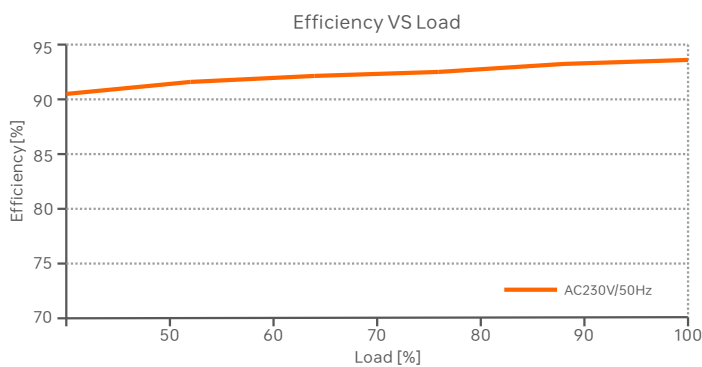

## Surge Current & Corresponding Miniature Circuit Breaker (MCB) Load Capacity Table

MCB Model	B10	B13	B16	B20	B25	C10	C13	C16	C20	C25	D10	D13	D16	D20	D25
Maximum Load Capacity	5	7	8	10	13	8	9	10	12	15	11	12	13	16	19

Remarks:

1. Test Conditions: Cold start 45A(Test twidth=300us tested under 50% Ipeak)/230V ~ .
2. The number of supported drivers may vary depending on the brand and model of the MCB.
- 3.It is recommended not to exceed the specified load capacity during on-site installation. The actual load should be determined based on field conditions.
- 4.If the ambient temperature exceeds 30°C or multiple MCBs are installed side by side, the number of installed drivers must be reduced and recalculated accordingly.
- 5.Electricians typically use Type B MCBs for residential lighting and Type C MCBs for commercial lighting applications.
- 6.Different testing equipment may yield variations in measured current peaks and pulse widths. Always use professional-grade instruments for accurate testing.

## Flicker Test Table

Limit Value of Modulation in Low Risk Areas	
Waveform frequency of Optical output (f)	Limit value (%)
f ≤ 8Hz	0.2
8Hz < f ≤ 90Hz	0.025 × f
90Hz < f ≤ 1250Hz	0.08 × f
f > 1250Hz	Exemption assessment
Limit Value of Modulation in No Effect Areas	
Waveform frequency of Optical output (f)	Limit value (%)
f ≤ 10Hz	0.1
10Hz < f ≤ 90Hz	0.01 × f
90Hz < f ≤ 3125Hz	(0.08/2.5) × f
f > 3125Hz	Exemption assessment (high frequency exemption)

Brightness

- ▲ 0.1%
- ▲ 1%
- ▲ 5%
- ◆ 10%
- 20%
- ▲ 30%
- 40%
- ★ 50%
- 60%
- 70%
- 80%
- 90%
- ◆ 100%

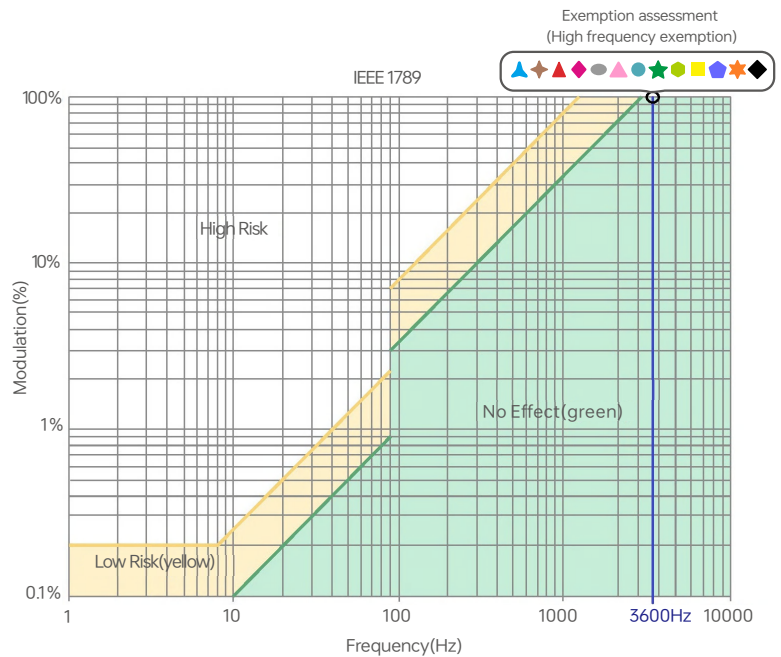

## Packaging Specification

Model	LM-75-24-G1D2F/LM-75-12-G1D2F
Packaging box size	315×215×240mm(L×W×H)
Quantity	10PCS per layer, 3 layers per box, 30PCS per box
Weight	0.29kg per PC, 9.6kg±5% per box

## Packaging Style Drawing

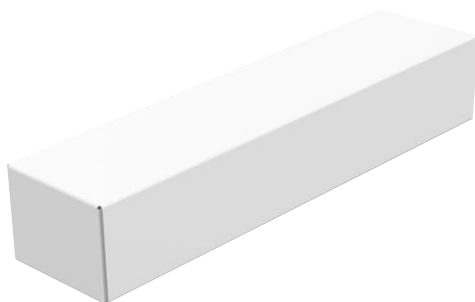

Inner packaging box



Full box packaging

## Transportation and Storage

### 1. Transportation

Products can be shipped via vehicles, boats and planes.

During transportation, products should be protected from rain and sun. Please avoid severe shock and vibration during the loading and unloading process.

### 2. Storage

The storage conditions should comply with the Class I Environmental Standards. The products that have been stored for more than six months are recommended to be re-inspected and can be used only after they have been qualified.

## Attentions

- Product installation and commissioning should be done by a qualified professional.
- LTECH products are and not lightningproof non-waterproof (special models excepted). Please avoid the sun and rain. When installed outdoors, please ensure they are mounted in a water proof enclosure or in an area equipped with lightning protection devices.
- Good heat dissipation will prolong the working life of products. Please ensure good ventilation.
- Please check if the working voltage used complies with the parameter requirements of products.
- The diameter of wire used must be able to load the light fixtures you connect and ensure the firm wiring.
- Before you power on products, please make sure all the wiring is correct in case of incorrect connection that causes damage to light fixtures.
- If a fault occurs, please do not attempt to fix products by yourself. If you have any question, please contact your suppliers.
- \* This manual is subject to changes without further notice. Product functions depend on the goods. Please feel free to contact our official distributors if you have any question.

## Warranty Agreement

- Warranty periods from the date of delivery: 5 years.
- Free repair or replacement services for quality problems are provided within warranty periods.

Warranty exclusions below:

- Beyond warranty periods.
- Any artificial damage caused by high voltage, overload, or improper operations.
- Products with severe physical damage.
- Damage caused by natural disasters and force majeure.
- Warranty labels and barcodes have been damaged.
- No any contract signed by LTECH.

1. Repair or replacement provided is the only remedy for customers. LTECH is not liable for any incidental or consequential damage unless it is within the law.
2. LTECH has the right to amend or adjust the terms of this warranty, and release in written form shall prevail.



## LED 智能色温驱动器 (恒压型)

- 外壳采用科思创/三星PC阻燃V0级原料
- 免螺丝压线翻盖设计, 可拆卸端盖, 按需调节壳体长度
- 支持全指令NFC极速编程, 可使用手机APP通过NFC更改调光方式、PWM、亮度范围等, 实现驱动器数据交互功能
- 支持0-10V、PUSH DIM/CCT、走廊灯调光调色温
- 共阳极两路SELV输出通道
- 恒功率设计, 调节不同色温保持亮度一致
- 调光范围0~100%, LED从0.01%开始调光
- 带软启动渐亮功能, 让人眼视觉更舒适
- 调光接口具备光电隔离, 符合最新的安规标准, 更安全可靠
- 符合欧盟能效ERP指令, 空载功耗 < 0.5W, 网络待机功耗 < 0.5W
- 创新的热管理技术, 智能保护电源寿命
- 过温、过压、过载、短路保护, 可自动恢复
- 适合室内I、II、III类灯具应用
- 常规使用下寿命可达10万小时
- 5年保修期 (采用红宝石电容)

无频闪  
IEEE 1789  
高频豁免考核级别

5合1调光  
0-10V  
1-10V  
10V PWM  
RX  
PUSH DIM/CCT  
0-10V接口消耗电流<0.05mA

Dimmable:  
1: 10000

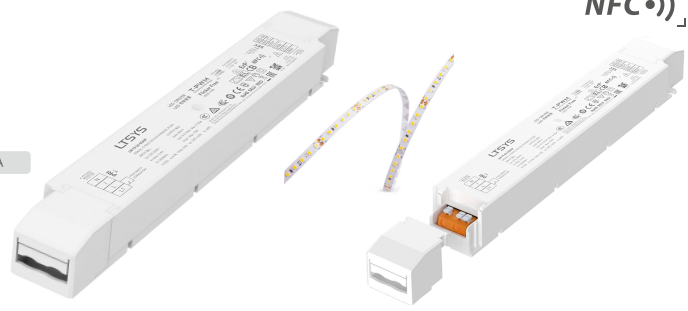

NFC

## 技术参数

型号	LM-75-24-G2A2F		
特征	输出类型	恒压	
	调光接口	0/1-10V, PUSH DIM/CCT	
	输出特征	隔离	
	防护等级	IP20	
	绝缘等级	II类(适用于室内I、II、III类灯具)	
输出	输出电压	24V $\overline{\text{m}}$	
	输出电压范围	24V $\pm$ 0.5V $\overline{\text{m}}$	
	输出电流	Max. 3.125A	
	输出功率	Max. 75W	
	输出功率范围	0-75W	
	频闪级别	高频豁免考核级别	
	调光范围	0-100%, 调光深度: 0.01%	
	过功率限制	$\geq 102\%$	
输入	纹波与噪声	$\leq 300\text{mV}$	
	PWM调光频率	300-22000Hz	
	输入交流电压	220-240V~	
	输入直流电压	220-240V $\overline{\text{m}}$ (EMI需配灯具后评估)	
	频率范围	50/60Hz	
	输入电流	Max. 0.4A/230V~	
	功率因数	PF>0.98/230V~ (满载)	
	总谐波失真THD	THD<10% @ 230V~ (满载)	
	效率(Typ.)	92%	
	浪涌电流	冷启动45A (在50%I <sub>peak</sub> 下测试t <sub>width</sub> =300us)/230V~	
	抗浪涌	L-N: 2KV	
漏电流	Max. 0.5mA		
环境	工作温度	ta: -20 ~ 50°C tc: 80°C	
	工作湿度	20 ~ 95%RH, 无冷凝	
	储存温度/湿度	-40 ~ 80°C, 10~95%RH	
	温度系数	$\pm 0.03\%/^{\circ}\text{C}$ (-20°C-50°C)	
	耐振动	10-500HZ, 2G 12分钟/周期, X, Y, Z轴各72分钟	
保护	过温保护	根据PCB温度超标情况( $\geq 110^{\circ}\text{C}$ ), 智能调节电流输出或关闭, 可自动恢复	
	过载保护	负载电流 $\geq 102\%$ , 关闭输出, 可自动恢复	
	短路保护	输出线路短路进入打嗝模式, 可自动恢复	
	过压保护	空载电压 $\geq 28\text{V}$ , 关闭输出, 可自动恢复	
安规和电磁规格	耐压	输入对输出: 3750V~	
	绝缘阻抗	输入对输出: 100M $\Omega$ /500VDC/25°C/70%RH	
	安全规范	CCC 中国	GB19510.1, GB19510.14, GB19510.213
		TUV 德国	EN61347-1, EN61347-2-13, EN62493
		CB CB成员国	IEC61347-1, IEC61347-2-13
		CE 欧盟	EN61347-1, EN61347-2-13, EN62384
		EAC 俄罗斯	IEC61347-1, IEC61347-2-13
		RCM 澳洲	AS 61347-1, AS 61347-2-13
	电磁兼容发射	ENEC 欧洲	EN61347-1, EN61347-2-13, EN62384
		CCC 中国	GB/T17743, GB17625.1
CE 欧盟		EN55015, EN61000-3-2, EN61000-3-3, EN61547	
EAC 俄罗斯		IEC62493, IEC61547, EH55015	
RCM 澳洲	EN55015, EN61000-3-2, EN61000-3-3, EN61547		
电磁兼容抗扰度	EN61000-4-2,3,4,5,6,8,11,EN61547		
ErP	功耗	网络待机功耗	< 0.5W (通过指令开关后)
		空载功耗	< 0.5W (不接灯具时)
	频闪/频闪效应	IEEE1789	满足无影响/高频豁免考核级别
		CIE SVM	PstLM $\leq 1.0$ , SVM $\leq 0.4$
其他	DF	相位因素	DF $\geq 0.9$
	产品重量	290g $\pm 10\text{g}$	
	产品尺寸	293 $\times$ 42.5 $\times$ 30mm(L $\times$ W $\times$ H)	

本款驱动器适合连接电阻限流的LED灯具(如LED灯条)。如果连接内置恒流IC限流的灯具, 会产生几十倍的瞬间浪涌电流, 导致驱动器会执行过载保护(打嗝频闪)。下单时这类内置恒流IC限流的灯具需要注明(如MR16灯杯、地埋灯、洗墙灯、恒流硬灯条等), 以便烧写特殊程序。

## 尺寸图

单位: mm

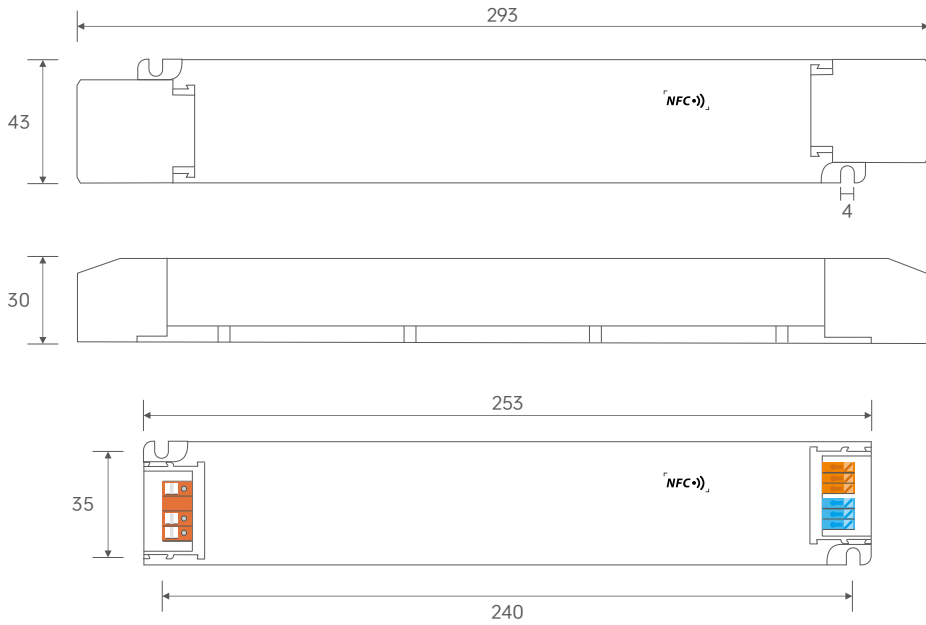

## 连接应用图

### 0-10V 连接方式

#### 1、调光: 单路单通道

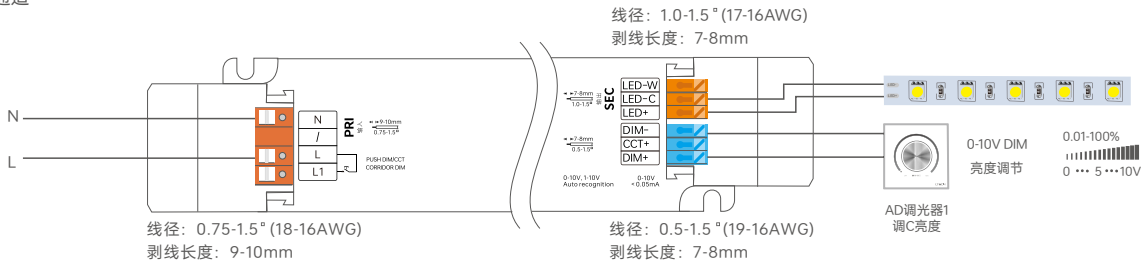

\*不同型号 / 功率的电源硬件有差异, 勿用于同一灯膜 / 灯箱调光, 避免启亮、调光效果不一致;  
建议同一灯膜 / 灯箱搭配同一型号的电源, 保障调光效果一致

#### 2、调光: 单路双通道(每个通道最大功率37.5W)

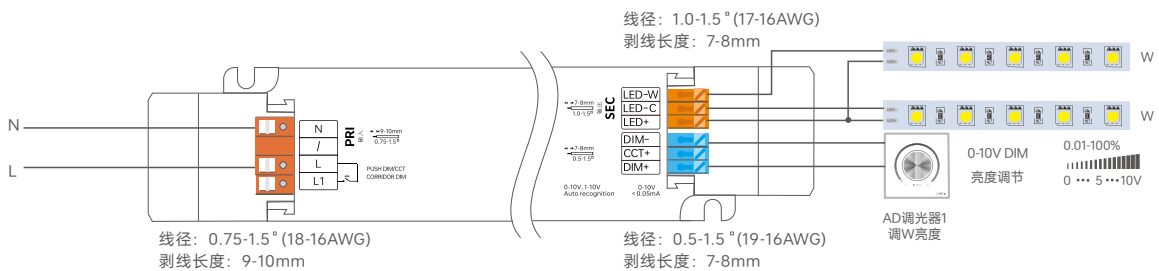

\*不同型号 / 功率的电源硬件有差异, 勿用于同一灯膜 / 灯箱调光, 避免启亮、调光效果不一致;  
建议同一灯膜 / 灯箱搭配同一型号的电源, 保障调光效果一致

#### 3、调光: 两路双通道(每个通道最大功率37.5W)

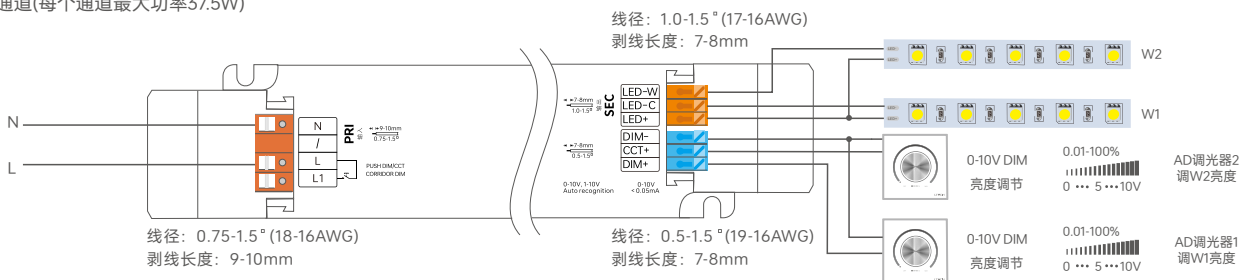

\*不同型号 / 功率的电源硬件有差异, 勿用于同一灯膜 / 灯箱调光, 避免启亮、调光效果不一致;  
建议同一灯膜 / 灯箱搭配同一型号的电源, 保障调光效果一致

4、色温模式：两路(使用两个调光接线方式)

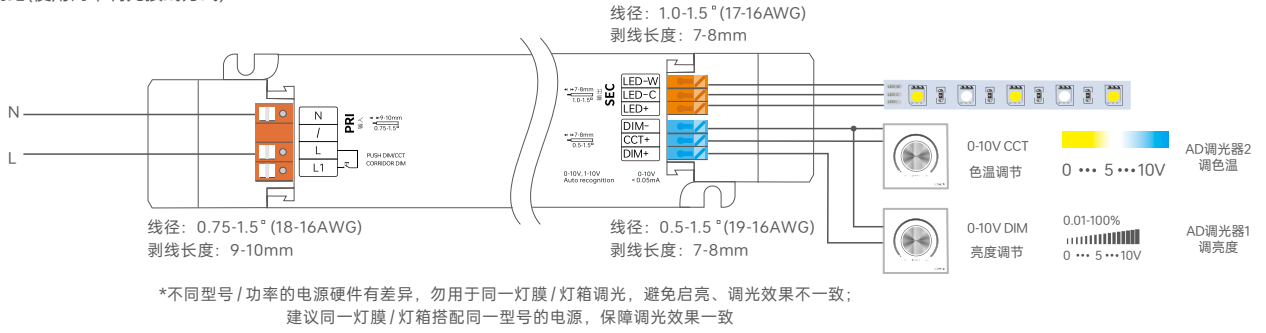

5、色温模式：两路(使用一个色温调光接线方式)

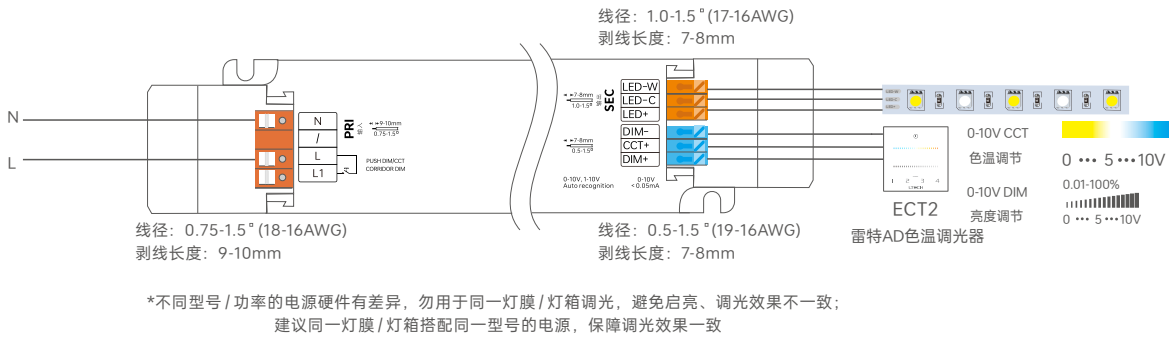

PUSH DIM/CCT 连接方式

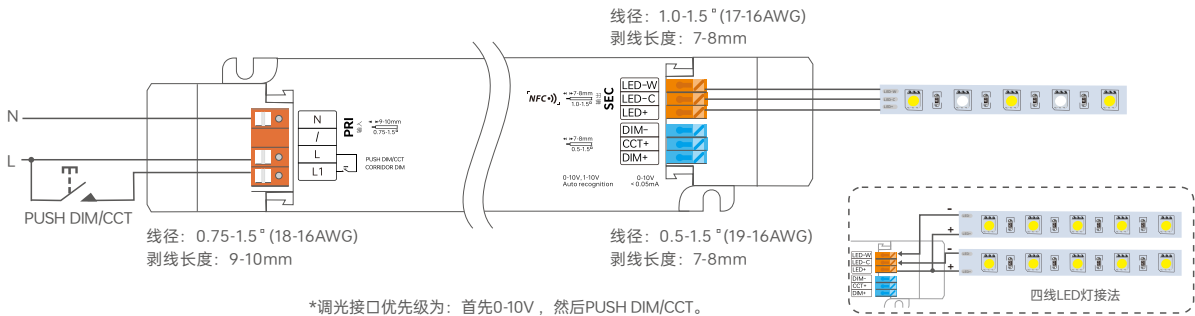

\* 采用恒功率程序设计, 色温调节全程能保持亮度一致, 电源可连接额定功率二倍的负载。  
75W电源, 可连接75W×2CH的负载, 恒功率设计, 两路总功率会保持在75W以内。

\*不同型号 / 功率的电源硬件有差异, 勿用于同一灯膜 / 灯箱调光, 避免启亮、调光效果不一致;  
建议同一灯膜 / 灯箱搭配同一型号的电源, 保障调光效果一致

切换至PUSH DIM/CCT 模式

方式 1: 若是已切换至走廊调光模式, 可以按照PUSH DIM/CCT接线图接好线路, 复位开关3秒内短按5次, 然后长按6秒后再3秒内短按5次, 驱动器将会自动切换至PUSH DIM/CCT模式。  
方式 2: 若是已切换至走廊模式, 可以通过NFC Lighting app切换成 PUSH 模式。

操作说明



复位开关

- 短按: 开关控制
- 双击: 切换亮度/色温模式
- 长按: 调节当前模式
- 调光记忆: 当再次开关时, 灯光会回到先前调整的亮度水平

## 走廊灯 连接方式

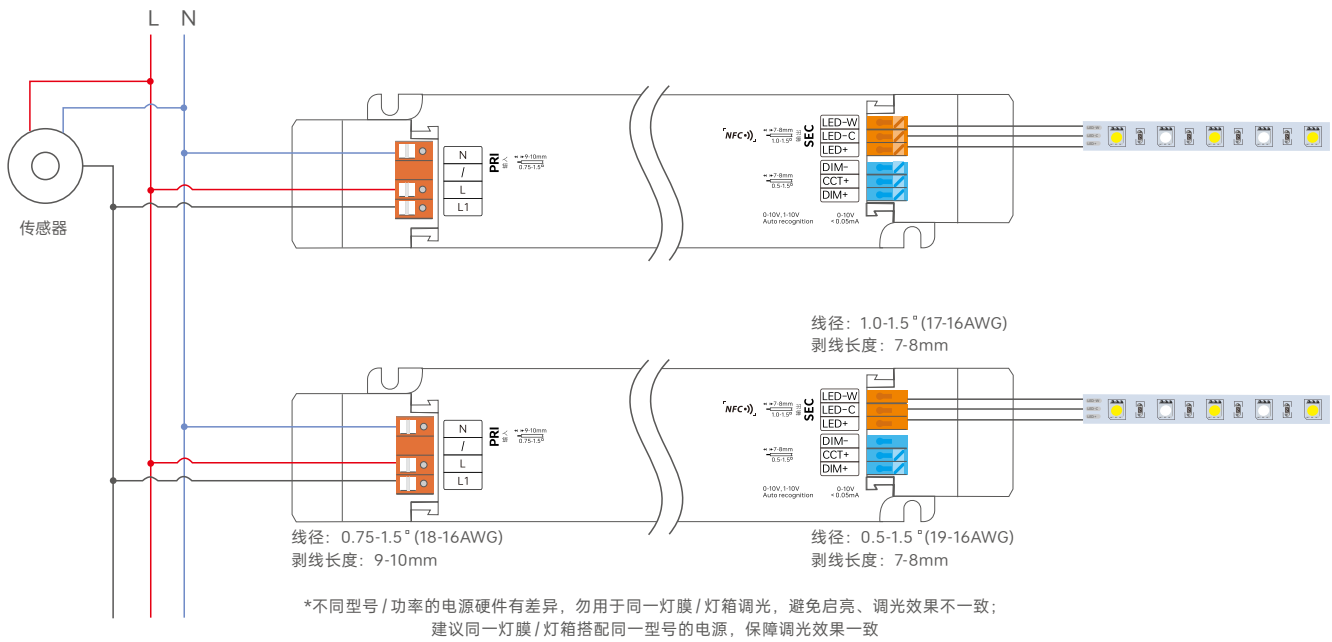

## 切换至走廊灯模式

方式 1: 通过NFC配置并切换走廊灯功能, PUSH DIM/CCT 功能关闭。

方式 2: 按照走廊调光接线图接好线后, 保持有效感应区域内移动并持续2分钟以上, 自动切换成走廊调光模式并全亮灯。

方式 3: 按照走廊调光接线图接好线后, 先将传感器更换为普通开关, 然后打开普通开关持续导通2分钟, 驱动器将自动切换到走廊调光模式, 然后将普通开关移除并更换回传感器。

备注: 正常工作时, 推荐将移动感应器的维持时间(Hold-time)设置为最小。

需要选用带AC开关的移动感应器。

## 走廊调光 工作过程

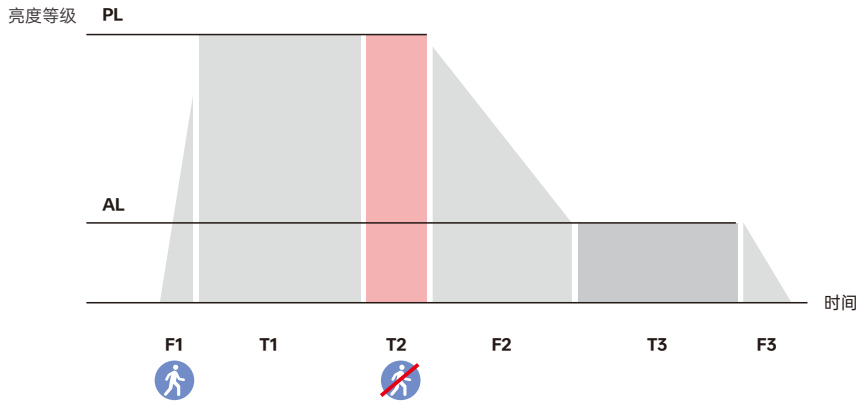

名称	默认	设置范围
(F1) 感应渐入时间	1 秒	0-100 秒
(PL) 感应亮度	255	0-255
(PC) 感应色温	0	0-255
(T1) 感应保持时间	通过传感器设置	
(T2) 感应延迟时间	30 秒	0 秒, 5 秒, 10 秒, 20 秒, 30 秒, 45 秒, 1 分钟, 2 分钟, 3 分钟, 5 分钟, 10 分钟, 20 分钟, 30 分钟
(F2) 无感应渐出时间	1 秒	0-100 秒
(AL) 无人守候亮度	100	0-255
(AC) 无人守候色温	0	0-255
(T3) 守候时间	30 秒	0 秒, 5 秒, 10 秒, 20 秒, 30 秒, 45 秒, 1 分钟, 2 分钟, 3 分钟, 5 分钟, 10 分钟, 20 分钟, 30 分钟, 永久
(F3) 渐出到关闭时间	1 秒	0-100 秒

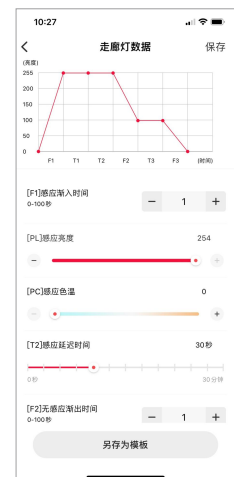

备注: \*如灯需要低亮度守候, 需要设置[T3]感应守候时间为永久

\*以上参数由NFC lighting APP 设置

## 搭配 NFC Lighting APP 使用

通过手机扫描下方二维码，按提示完成APP安装。(因性能需求，要求手机型号苹果：iPhone 8及以上、且操作系统iOS13及以上； 安卓：具备NFC功能机型)



\* 设置驱动器参数时，必须在驱动器断电情况下进行操作。

### 读/写智能电源

使用手机，通过NFC读取驱动器信息，根据需求设置参数后，可直接写入驱动器。

#### 1. 读取驱动器

在APP“首页”点击【读/写智能电源】，将手机感应区域靠近驱动器NFC感应区，读取驱动器参数。



#### 2. 编辑参数

点击【参数管理】可编辑选择品牌、调光方式、通电渐变时间、调光曲线、PWM频率、亮度范围、走廊灯等参数。

#### 3. 写入驱动器

参数设置完成后，点击右上角【写入】，将手机感应区域靠近驱动器NFC感应区，即可写入驱动器成功修改参数。



## 保护盖应用图

压线板

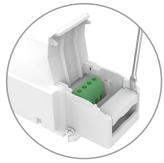

1. 使用工具撬起压线板侧边即可拆下。

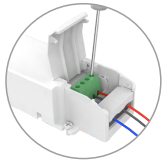

2. 使用螺丝批按照接线图接线。

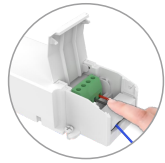

3. 向下按压压线板固定住线合上保护盖即可。

保护盖的拆装



在底部左右掰动，即可将保护盖拆下。

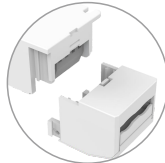
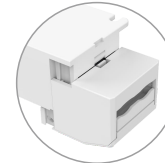

## 安装注意事项

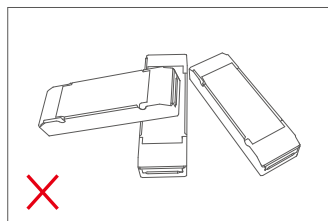

请勿将产品堆叠摆放，产品与产品间距离应 $\geq 15\text{cm}$ ，避免影响产品散热和使用寿命。

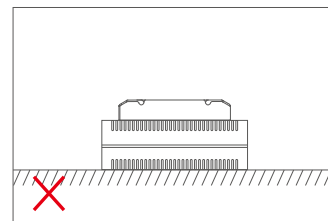
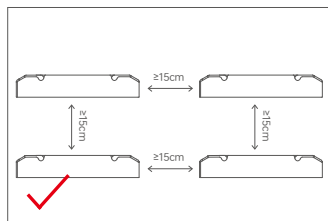

请勿将产品置于电源上方，与电源间距离应 $\geq 15\text{cm}$ ，避免影响产品散热而减少使用寿命。

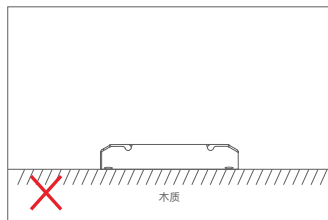
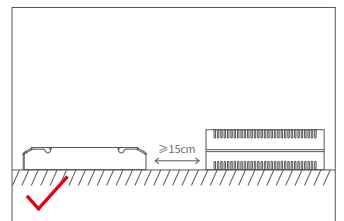

请勿将产品螺丝固定紧贴于木板，应在固定螺丝下增加 $\geq 7\text{mm}$ 的垫片，留点空隙可以有效散热，避免影响产品散热和使用寿命。

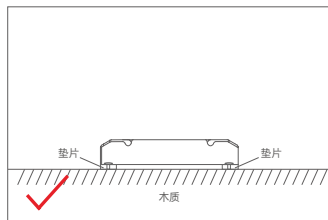

## 关系图表

效率与负载关系图

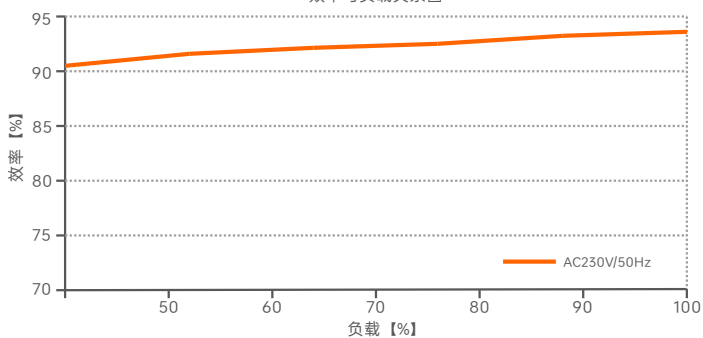

功率因数特征图

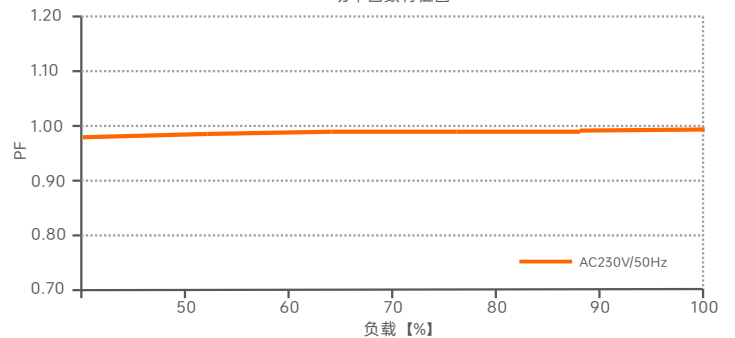

THD与负载关系图

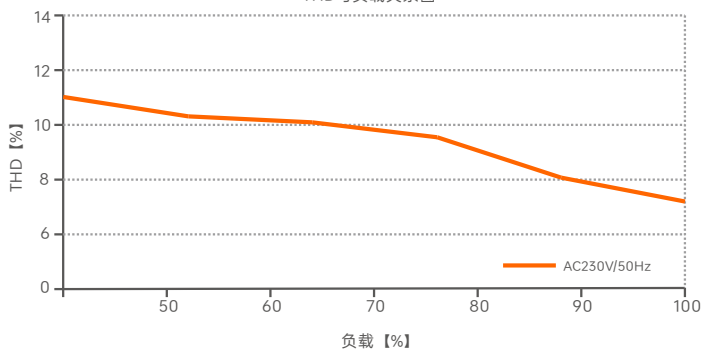

寿命与外壳温度关系图

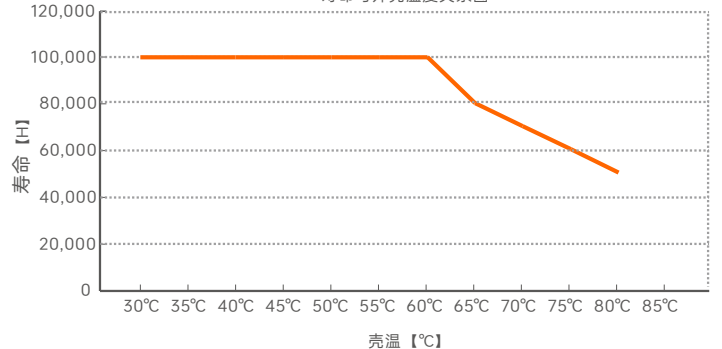

## 浪涌电流&对应的微型断路器(MCB)下挂载的数量对应表

微型断路器型号	B10	B13	B16	B20	B25	C10	C13	C16	C20	C25	D10	D13	D16	D20	D25
最大带载数量	5	7	8	10	13	8	9	10	12	15	11	12	13	16	19

备注:

1. 本数据测试条件: 冷启动, 45A(在50%Ipeak下测试twidth=300us)/230V~;
2. 对于不同品牌和型号的微型断路器, 驱动器的数量会有所不同;
3. 现场安装时建议不要超过上述数量, 具体负载量以现场安装为准;
4. 当微型断路器的安装环境温度超过30°C或多个微型断路器并排安装时, 安装的驱动器数量将减少, 这需要重新计算;
5. 电工通常考虑将B型MCB用于家用照明, 将C型MCB用于商业照明;
6. 不同仪器设备测试出来的电流峰值和脉冲宽度有差异, 请使用专业仪器设备测试;

## 频闪测试表

IEEE 1789	
低风险区域 (Low Risk) 的波动深度 (Modulation) 限值	
光输出波形频率 $f$	限值 (%)
$f \leq 8\text{Hz}$	0.2
$8\text{Hz} < f \leq 90\text{Hz}$	$0.025 \times f$
$90\text{Hz} < f \leq 1250\text{Hz}$	$0.08 \times f$
$f > 1250\text{Hz}$	免除考核
无风险区域 (No Effect) 的波动深度 (Modulation) 限值	
光输出波形频率 $f$	限值 (%)
$f \leq 10\text{Hz}$	0.1
$10\text{Hz} < f \leq 90\text{Hz}$	$0.01 \times f$
$90\text{Hz} < f \leq 3125\text{Hz}$	$(0.08/2.5) \times f$
$f > 3125\text{Hz}$	免除考核 (高频豁免)

亮度

- ▲ 0.1%
- ◆ 1%
- ▲ 5%
- ◆ 10%
- 20%
- ▲ 30%
- 40%
- ★ 50%
- 60%
- 70%
- 80%
- ★ 90%
- ◆ 100%

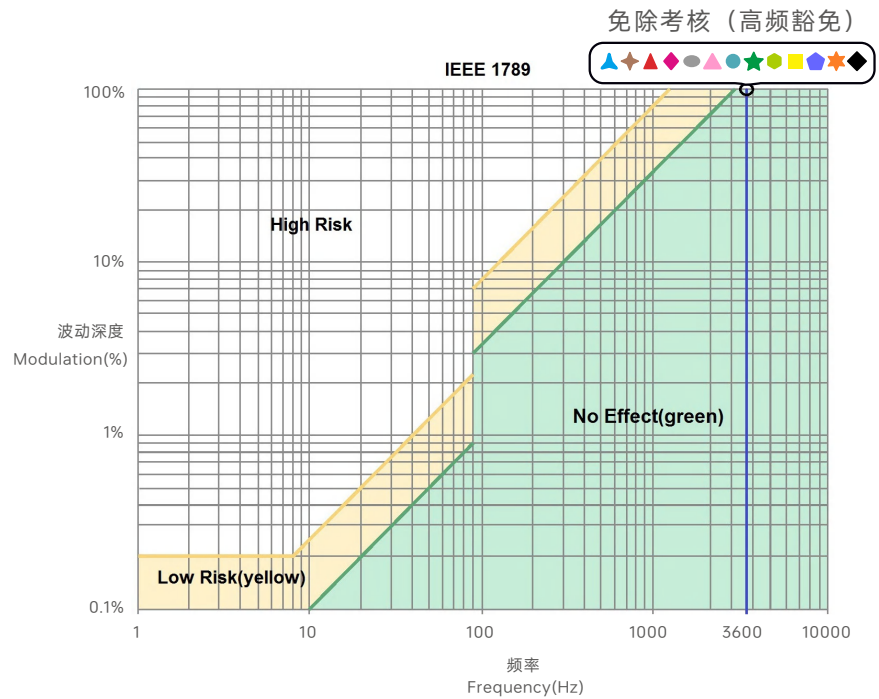

## 包装规格

型号	LM-75-24-G2A2F
包装箱尺寸	315×215×240mm(L×W×H)
数量	10个/层; 3层/箱; 30个/箱
重量	0.29kg/个; 9.6kg±5%/箱

## 包装样式图

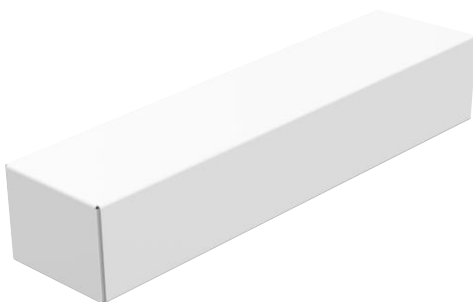

内包装盒



整箱包装

## 运输和贮存

### 1. 运输

产品适用车、船、飞机交通运输工具运输。

在运输中，应使用遮篷进行防雨和防晒，并保持文明装卸，不应有剧烈振动、撞击等。

### 2. 贮存

贮存符合I类环境的规定。贮存期限超过6个月的产品建议重新检验，合格后方可使用。

## 注意事项

- 请由具有专业资格的人员进行调试安装;
- 雷特产品(专有型号除外)不能防水,需避免日晒雨淋,如安装在户外,请用防水箱;
- 良好的散热条件会延长产品的使用寿命,请把产品安装在通风良好的环境;
- 请检查使用的工作电压是否符合产品的参数要求;
- 使用的电线直径大小必须能够负载连接的LED灯具,并确保接线牢固;
- 通电调试前,应确保所有接线正确,以避免因接线错误而导致灯具损坏;
- 如果发生故障,请勿私自维修;如有疑问,请联系供应商。

\* 本说明书的内容如有变更,恕不另行通知。若内容与您使用的功能有所不同,则以实物为准。如有疑问,欢迎向我司授权的经销商咨询。

## 保修条例

- 自出厂之日起保修服务期为5年。
- 在保修服务期内出现产品质量问题雷特科技将给予免费修理或更换服务。

非保修条例:

属下列情况不在免费保修或更换服务范围之内:

- 已经超出保修服务期;
- 过高电压、超负载、操作不当等人为造成的损坏;
- 产品外形严重损坏或变形;
- 自然灾害以及人力不可抗拒原因造成的损坏;
- 产品保修标签和产品唯一条形码损坏;
- 无雷特科技签订的合同或发票凭证。

1. 修理或更换是雷特科技对客户的一补救措施。雷特科技不承担任何附带引起的损害赔偿,除非在适用法律范围之内。
2. 雷特科技享有修正或调整本保修条款的权利,并以书面形式发布为准。